

D
Index**KDT 3.60 - 3.80**

Pos.	Ident No.	Description
□	549000 21100	SET OF SEALS ¹⁾
6	000100 21600	PUMP BODY, KDT 3.60
6	000100 21100	PUMP BODY, KDT 3.80
9	020004 21100	ROTOR
11	901330 00000	CARBON VANES (4x) ²⁾
15	000801 21100	LID
16	000701 21100	LID
18	001100 21100	BEARING COVER
19	001000 21100	BEARING COVER
20	025511 21100	GASKET
24	911312 00000	SEAL
26	917152 00000	COMPENSATING DISC
27	906540 00000	SHAFT-SEALING RING
28	906612 50000	BALL BEARING
29	906657 00000	BALL BEARING
31	511400 10100	SET DISTANCE DISC
37	945217 00000	HEX HEAD SCREW
38	016801 21100	CLAMPING DISC
39	949807 00000	SCREW
41	945224 00000	HEX-HEAD SCREW
42	945220 00000	HEX-HEAD SCREW
45	948742 00000	STRAIGHT PIN
47	947736 00000	KEY
50	053201 21100	CONNECTION FLANGE
52	950308 00000	WASHER
53	945337 00000	SOCKET HEAD SCREW
57	949409 00000	WASHER
58	945270 00000	SHAFT END BOLD
61	040101 21100	FILTER HOUSING
62	025501 21100	GASKET
64	946955 00000	STUD
65	951003 00000	STUD
67	964407 00000	SILENCER TUBE
68	909507 00000	FILTER CARTRIDGE C 1112/2 (1x) ²⁾
71	009000 27000	LEAF SPRING
72	948750 00000	BLIND RIVET
73	040201 21100	FILTER-COVER
75	025518 21100	GASKET
76	025516 21100	GASKET
77	022802 21100	FILTER HOLDER
79	945320 00000	SOCKET HEAD SCREW
80	946944 00000	STUD
81	947504 00000	WASHER
82	947104 00000	HEX.NUT
83	952019 00000	LOCATING PEG
85	025514 21100	GASKET
86	025515 21100	GASKET
88	560203 21100	COOLER
91	909510 00000	FILTER CARTRIDGE C 713 (1x) ²⁾
93	946965 00000	STUD
94	947105 00000	HEX.NUT
95	949450 00000	WASHER
97	950304 00000	WASHER
98	945322 00000	SOCKET HEAD SCREW
103	068801 21100	COVER
104	025513 21100	GASKET
105	945319 00000	SOCKET HEAD SCREW
110	921500 50000	HANDLE
121	560204 21100	COOLER
125	025504 21100	GASKET

**D**
Index**KDT 3.60 - 3.80**

Pos.	Ident No.	Description
126	025512 21100	GASKET
127	025517 21100	GASKET
129	945372 00000	SOCKET HEAD SCREW
130	945328 00000	SOCKET HEAD SCREW
132	946930 00000	STUD
134	005602 21100	COVER
141	016606 21100	CONNECTING PIECE
146	025507 21100	GASKET
148	945368 00000	SOCKET HEAD SCREW
149	741310 30000	RUBBER BUFFER
161	918300 21100	COVERING HOOD
163	920800 21100	AIR GUIDE HOOD
165	960700 21100	VENTILATOR HOOD
166	960701 21100	VENTILATOR HOOD
170	945321 00000	SOCKET HEAD SCREW
171	945371 00000	SOCKET HEAD SCREW
173	949806 00000	SCREW
174	951703 00000	SPRING DISC
175	741302 00000	RUBBER BUFFER
176	945634 00000	THREADED PIN
178	951602 00000	RING UNIT
182	014900 21100	FLANGES
184	951916 00000	RUBBER BUSHING
185	948772 00000	PIPE RIVET
186	947508 00000	WASHER
188	945333 00000	SOCKET HEAD SCREW
190	951018 00000	STUD
191	947506 00000	WASHER
192	947106 00000	HEX.NUT
195	902108 00000	COUPLING
196	902209 00000	COUPLING DISC
197	544501 21100	COUPLING WITH FAN
285	728000 99622	PRESSURE REGULATING VALVE / 8,7 PSI
285	728001 99622	PRESSURE REGULATING VALVE / 14,5 PSI
285	728002 99622	PRESSURE REGULATING VALVE / 29 PSI
288	948066 00000	SEALING RING
290	964307 00000	SILENCER TUBE
291	912805 00000	PLUG
400	769302 40840	FREQUENCY CONVERTOR
401	961301 19600	GASKET
402	945315 00000	SOCKET HEAD SCREW

¹⁾ Set of seals - 54900021100 - Pos.: 20, 24, 62, 75, 76, 85, 86, 104, 125, 126, 127, 146, 288²⁾ necessary order quantity / maintenance

OPTIONAL

KDT 3.60	USA	all types
KDT 3.80	/0-05	Special design – corrosion protection
	/0-34	Special design – > air flow rate
	/0-52	Special design – corrosion protection and special vanes
	/0-54	Special design – refrigeration
	/0-400	Special design – with frequency convertor
	/6	Special design – corrosion protection
	/B5-200	Special design – motor flange

Items different from standard appliance see appendix (back of drawing) 

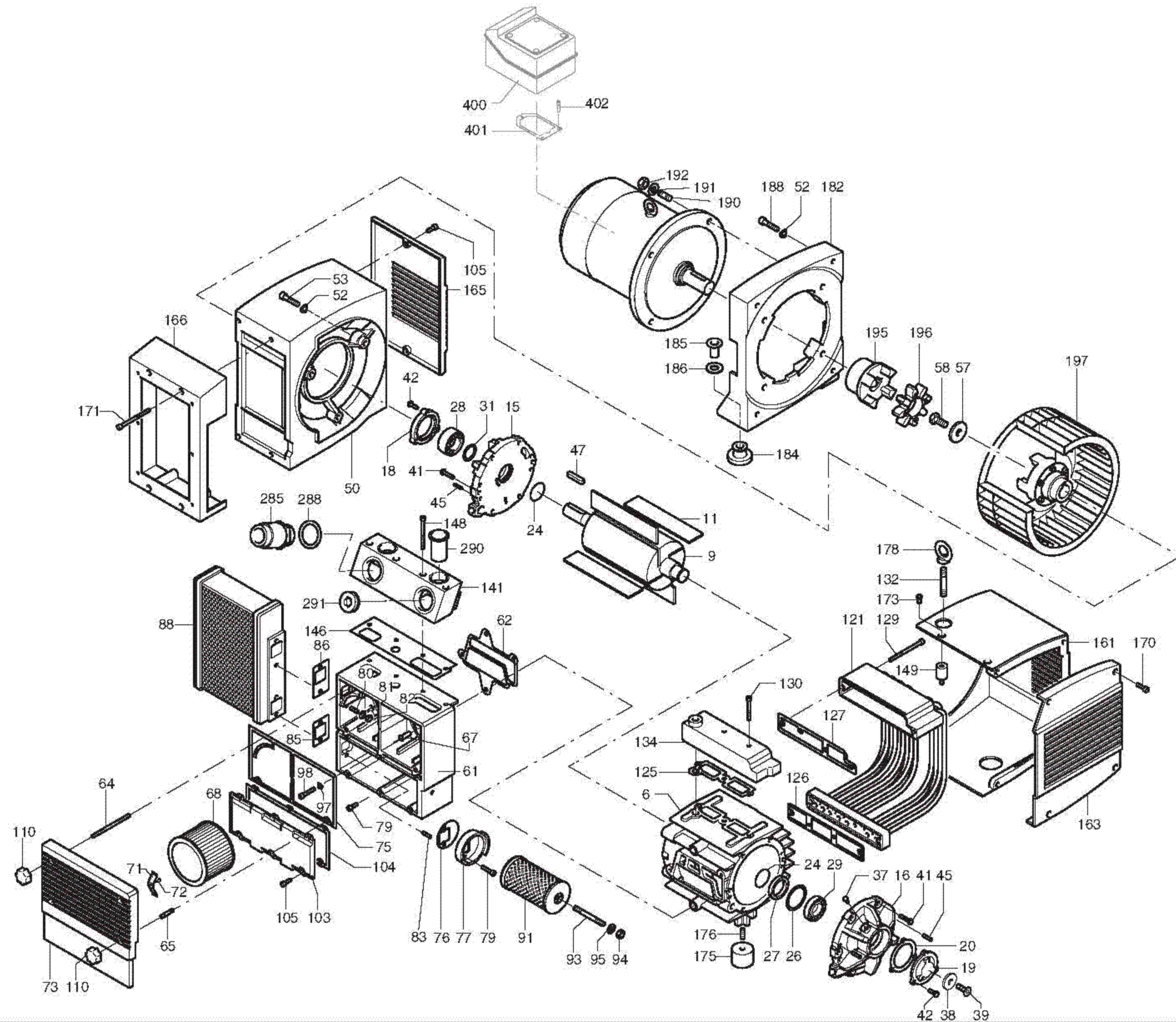
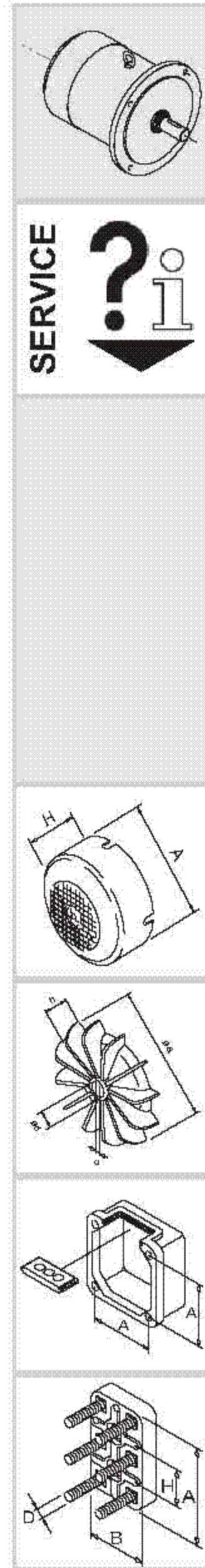

standard

KDT 3.60

KDT 3.80

optional
en option
opcionale
opcional