



Index	Pos.	Ident No.	Description	
DT 4.4	3	948029 00000	SEALING RING A 14x18x2	
	4	951228 02000	LOCKING SCREW G 1/4"	
	5	948034 00000	SEALING RING A 17x21x1,5	
	6	951228 00000	LOCKING SCREW G 3/8"	
	21	903247 00000	GASKET	
	22	903248 00000	GASKET	
	23	000100 27100	PUMP-BODY	
	24	945307 00000	SOCKET HEAD SCREW	
	25	020000 27100	ROTOR	
	26	960600 03000	FILLING PIECE	
	27	901387 00000	CARBON VANES (5x)*	
	29	909580 00000	FILTER CARTRIDGE (1x)	
	30	000700 27100	LID	
	31	945312 00000	SOCKET HEAD SCREW	
101	943138 00000	NOZZLE		
104	728000 99687	PRESSURE REGULATING VALVE		

DT 4.8	3	948034 00000	SEALING RING A 17x21x1,5	
	4	951228 00000	LOCKING SCREW G 3/8"	
	21	903250 00000	GASKET	
	22	903249 00000	GASKET	
	23	000100 27200	PUMP-BODY	
	24	945308 00000	SOCKET HEAD SCREW	
	25	020000 27200	ROTOR	
	26	960600 09000	FILLING PIECE	
	27	901388 00000	CARBON VANES (5x)*	
	29	909581 00000	FILTER CARTRIDGE (1x)	
	30	000700 27200	LID	
	31	945314 00000	SOCKET HEAD SCREW	
	101	943139 00000	SILENCING NOZZLE	
	104	728000 99687	PRESSURE REGULATING VALVE	

Index	Pos.	Ident No.	Description	
VT 4.4	3	948029 00000	SEALING RING A 14x18x2	
	4	951228 02000	LOCKING SCREW G 1/4"	
	5	948034 00000	SEALING RING A 17x21x1,5	
	6	951228 00000	LOCKING SCREW G 3/8"	
	21	903247 00000	GASKET	
	22	903248 00000	GASKET	
	23	000100 27100	PUMP-BODY	
	24	945307 00000	SOCKET HEAD SCREW	
	25	020000 27100	ROTOR	
	26	960600 03000	FILLING PIECE	
	27	901387 00000	CARBON VANES (5x)*	
	29	909580 00000	FILTER CARTRIDGE (1x)	
	30	000700 27100	LID	
	31	945312 00000	SOCKET HEAD SCREW	
102	736000 99688	VACUUM REGULATING VALVE		
103	727500 99689	BLOW-OFF VALVE		

VT 4.8	3	948034 00000	SEALING RING A 17x21x1,5	
	4	951228 00000	LOCKING SCREW G 3/8"	
	21	903250 00000	GASKET	
	22	903249 00000	GASKET	
	23	000100 27200	PUMP-BODY	
	24	945308 00000	SOCKET HEAD SCREW	
	25	020000 27200	ROTOR	
	26	960600 09000	FILLING PIECE	
	27	901388 00000	CARBON VANES (5x)*	
	29	909581 00000	FILTER CARTRIDGE (1x)	
	30	000700 27200	LID	
	31	945314 00000	SOCKET HEAD SCREW	
	102	736000 99688	VACUUM REGULATING VALVE	
	103	727500 99689	BLOW-OFF VALVE	

* necessary order quantity / maintenance

Drawing - see appendix 

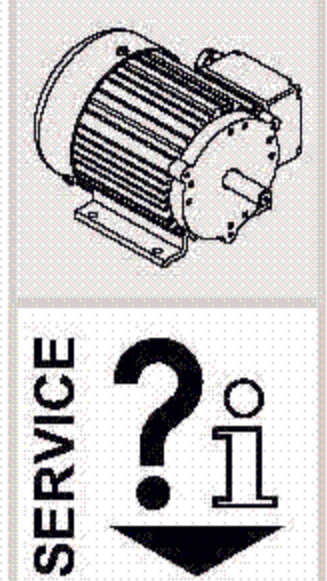

SERVICE ? i

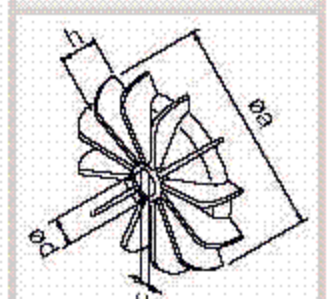
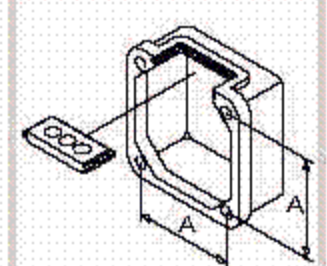
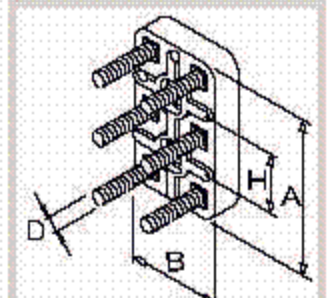
1~

C = ? μF
U = ? V

Druck
Pressure
Pression
Pressione
Presión

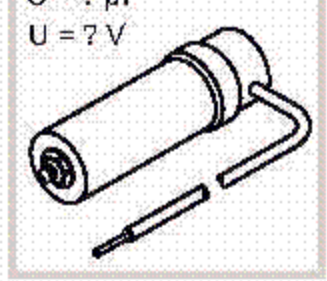
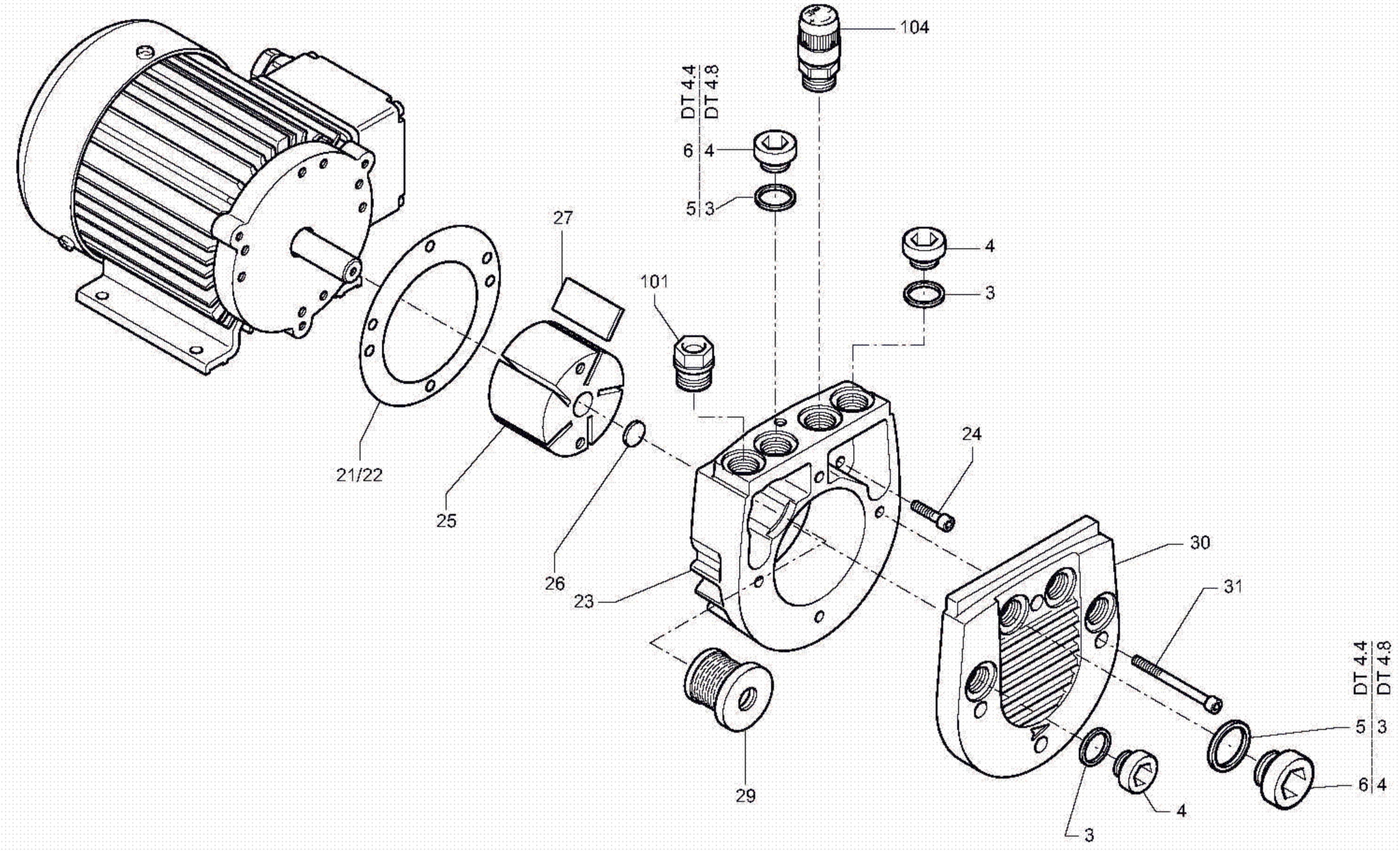
DT 4.4
DT 4.8

Vakuum
Vacuum
Vide
Vuoto
Vacío